



# ROOF-H Roof fan

The power of AIR



### Application

Range of centrifugal roof mounted fans in horizontal discharge format.

ROOF-H are designed for ventilation:

- warehouses, shop and industrial halls, farm buildings in agriculture, etc.

Due to their high temperature resistance, they are especially recommended as extractors:

- from over grates, from hoods in the meat industry and gastronomy.

### Construction

- rotors with backward blades are made of aluminum sheet,
- the base and outer casing are made of aluminum sheet,
- brackets and motor support plate are made of stainless steel,
- canopy made of aluminum sheet,
- rotor cover made of powder coated steel,
- designed for vertical work,
- suitable for mounting on flat roofs,
- working temperature  $-40^{\circ}\text{C}$  to  $+120^{\circ}\text{C}$ .

### Motor

- asynchronous single-phase 230V 50Hz (power to 1,1 kW)
- asynchronous 3-phase 230 / 400V, 50Hz (power up to 3,0 kW),
- asynchronous 3-phase 400 / 690V, 50Hz (power from 4,0 kW),
- degree of protection IP55,
- insulation class F,
- single-phase motors are adapted to voltage regulation,
- three-phase motors are adapted for frequency converter.



### RELATED PRODUCTS

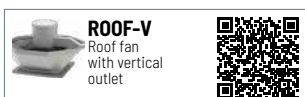



## NOMINAL DATA

type	airflow max	pressure max	speed	voltage rated	current max abs.**	power max abs.	sound pressure level*	weight	article number
<b>SINGLE-PHASE, 4-POLE MOTORS</b>									
ROOF-H/25/12/14S	1 220 m <sup>3</sup> /h	185 Pa	1 420 rpm	230 V	1,4 A	0,18 kW	54 dB(A)	17,0 kg	43534396
ROOF-H/28/17/14S	1 700 m <sup>3</sup> /h	235 Pa	1 340 rpm	230 V	1,7 A	0,25 kW	57 dB(A)	19,0 kg	43534401
ROOF-H/31/24/14S	2 400 m <sup>3</sup> /h	300 Pa	1 420 rpm	230 V	2,8 A	0,37 kW	60 dB(A)	22,0 kg	43534406
ROOF-H/35/34/14S	3 400 m <sup>3</sup> /h	385 Pa	1 430 rpm	230 V	3,8 A	0,55 kW	63 dB(A)	32,0 kg	43534411
ROOF-H/40/50/14S	5 000 m <sup>3</sup> /h	490 Pa	1 430 rpm	230 V	4,1 A	0,75 kW	66 dB(A)	36,0 kg	43534416
ROOF-H/45/71/14S	7 100 m <sup>3</sup> /h	620 Pa	1 300 rpm	230 V	7,5 A	1,1 kW	69 dB(A)	50,0 kg	43534421
<b>SINGLE-PHASE, 6-POLE MOTORS</b>									
ROOF-H/25/08/09S	800 m <sup>3</sup> /h	80 Pa	880 rpm	230 V	1,4 A	0,12 kW	52 dB(A)	18,0 kg	43534398
ROOF-H/28/11/09S	1 100 m <sup>3</sup> /h	105 Pa	880 rpm	230 V	1,4 A	0,12 kW	54 dB(A)	18,0 kg	43534403
ROOF-H/31/16/09S	1 600 m <sup>3</sup> /h	130 Pa	880 rpm	230 V	1,4 A	0,12 kW	57 dB(A)	20,0 kg	43534408
ROOF-H/35/22/09S	2 250 m <sup>3</sup> /h	170 Pa	920 rpm	230 V	1,6 A	0,18 kW	60 dB(A)	28,0 kg	43534413
ROOF-H/40/32/09S	3 200 m <sup>3</sup> /h	215 Pa	940 rpm	230 V	2,3 A	0,25 kW	63 dB(A)	33,0 kg	43534418
ROOF-H/45/47/09S	4 700 m <sup>3</sup> /h	270 Pa	930 rpm	230 V	2,9 A	0,37 kW	66 dB(A)	44,0 kg	43534423
ROOF-H/50/64/09S	6 400 m <sup>3</sup> /h	340 Pa	940 rpm	230 V	5,2 A	0,75 kW	69 dB(A)	55,0 kg	43534428
<b>THREE-PHASE, 4-POLE MOTORS</b>									
ROOF-H/25/12/14T	1 220 m <sup>3</sup> /h	185 Pa	1 400 rpm	400 V	0,55 A	0,18 kW	54 dB(A)	19,0 kg	43534395
ROOF-H/28/17/14T	1 700 m <sup>3</sup> /h	235 Pa	1 410 rpm	400 V	0,8 A	0,25 kW	57 dB(A)	20,0 kg	43534400
ROOF-H/31/24/14T	2 400 m <sup>3</sup> /h	300 Pa	1 410 rpm	400 V	1,1 A	0,37 kW	60 dB(A)	23,0 kg	43534405
ROOF-H/35/34/14T	3 400 m <sup>3</sup> /h	385 Pa	1 420 rpm	400 V	1,6 A	0,55 kW	63 dB(A)	31,0 kg	43534410
ROOF-H/40/50/14T	5 000 m <sup>3</sup> /h	490 Pa	1 430 rpm	400 V	2,1 A	0,75 kW	66 dB(A)	36,0 kg	43534415
ROOF-H/45/71/14T	7 100 m <sup>3</sup> /h	620 Pa	1 430 rpm	400 V	2,5 A	1,1 kW	69 dB(A)	55,0 kg	43534420
ROOF-H/50/97/14T	9 700 m <sup>3</sup> /h	765 Pa	1 450 rpm	400 V	4,6 A	2,2 kW	73 dB(A)	73,0 kg	43534425
ROOF-H/56/136/14T	13 600 m <sup>3</sup> /h	950 Pa	1 460 rpm	400 V	6,7 A	3,0 kW	76 dB(A)	76,0 kg	43534430
<b>THREE-PHASE, 6-POLE MOTORS</b>									
ROOF-H/25/08/09T	800 m <sup>3</sup> /h	80 Pa	870 rpm	400 V	0,65 A	0,12 kW	52 dB(A)	17,0 kg	43534397
ROOF-H/28/11/09T	1 100 m <sup>3</sup> /h	105 Pa	870 rpm	400 V	0,65 A	0,12 kW	54 dB(A)	17,0 kg	43534402
ROOF-H/31/16/09T	1 600 m <sup>3</sup> /h	130 Pa	870 rpm	400 V	0,65 A	0,12 kW	57 dB(A)	19,0 kg	43534407
ROOF-H/35/22/09T	2 250 m <sup>3</sup> /h	170 Pa	900 rpm	400 V	0,7 A	0,18 kW	60 dB(A)	27,0 kg	43534412
ROOF-H/40/32/09T	3 200 m <sup>3</sup> /h	215 Pa	880 rpm	400 V	1,0 A	0,25 kW	63 dB(A)	31,0 kg	43534417
ROOF-H/45/47/09T	4 700 m <sup>3</sup> /h	270 Pa	880 rpm	400 V	1,3 A	0,37 kW	66 dB(A)	44,0 kg	43534422
ROOF-H/50/64/09T	6 400 m <sup>3</sup> /h	340 Pa	940 rpm	400 V	2,0 A	0,75 kW	69 dB(A)	56,0 kg	43534427
ROOF-H/56/90/09T	9 000 m <sup>3</sup> /h	430 Pa	940 rpm	400 V	2,8 A	1,1 kW	73 dB(A)	64,0 kg	43534432
ROOF-H/63/129/09T	12 900 m <sup>3</sup> /h	540 Pa	965 rpm	400 V	5,0 A	2,2 kW	74 dB(A)	105,0 kg	43534437
ROOF-H/71/184/09T	18 400 m <sup>3</sup> /h	690 Pa	965 rpm	400 V	6,2 A	3,0 kW	81 dB(A)	147,0 kg	43534442
ROOF-H/80/264/09T	26 400 m <sup>3</sup> /h	840 Pa	960 rpm	400 V	13,3 A	5,5 kW	85 dB(A)	190,0 kg	43534447

\* Measurement made at a distance of 1.5m from the outlet, for  $Q = 2/3 * Q_{max}$   
 \*\* value of the rated current may vary depending on the manufacturer of the electric motor used.



## PERFORMANCE CHARACTERISTICS OF THE FANS

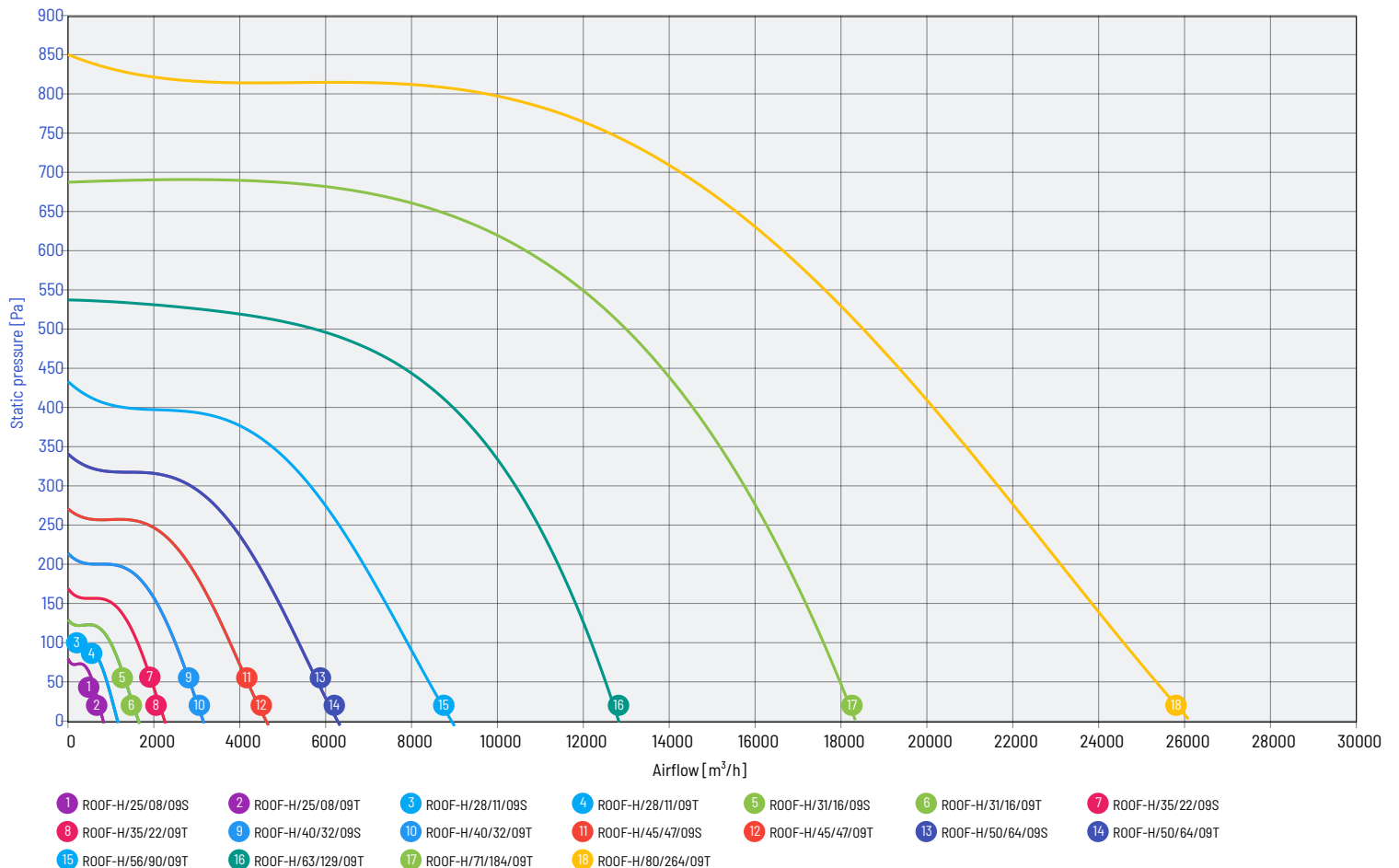
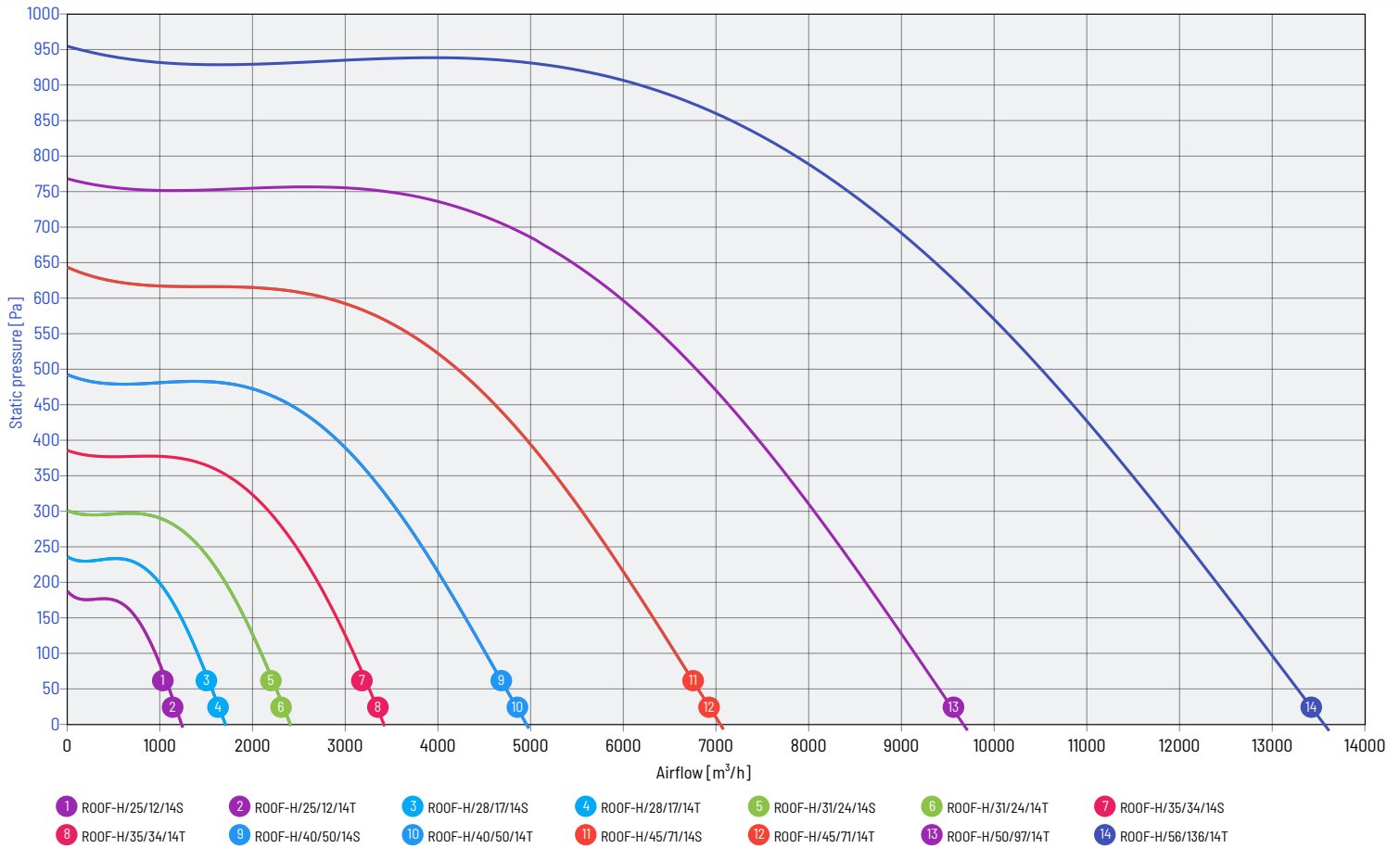



## PERFORMANCE CHARACTERISTICS OF THE FANS

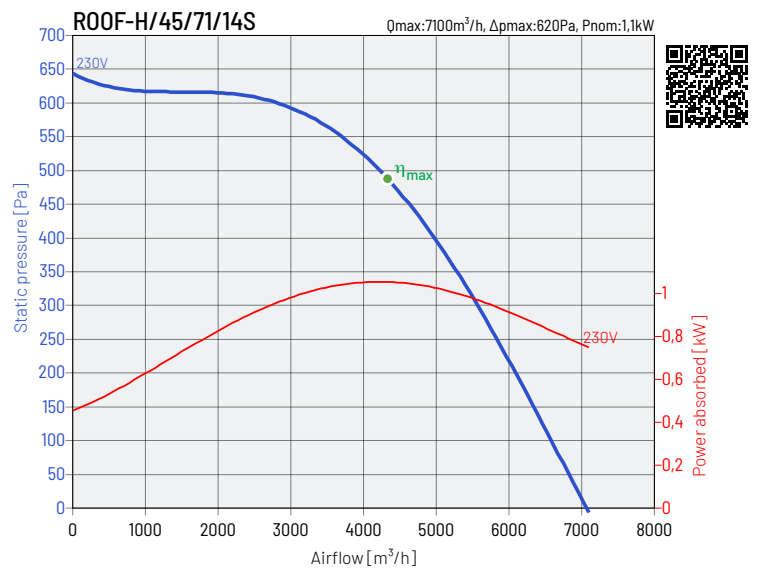
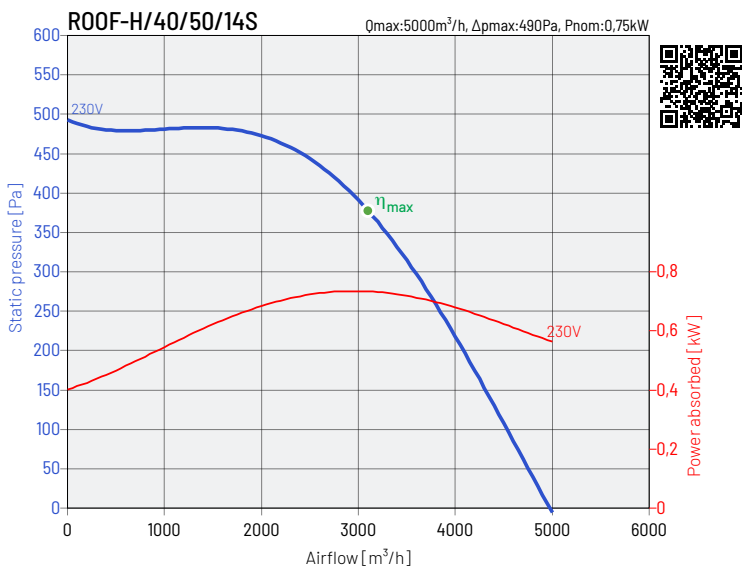
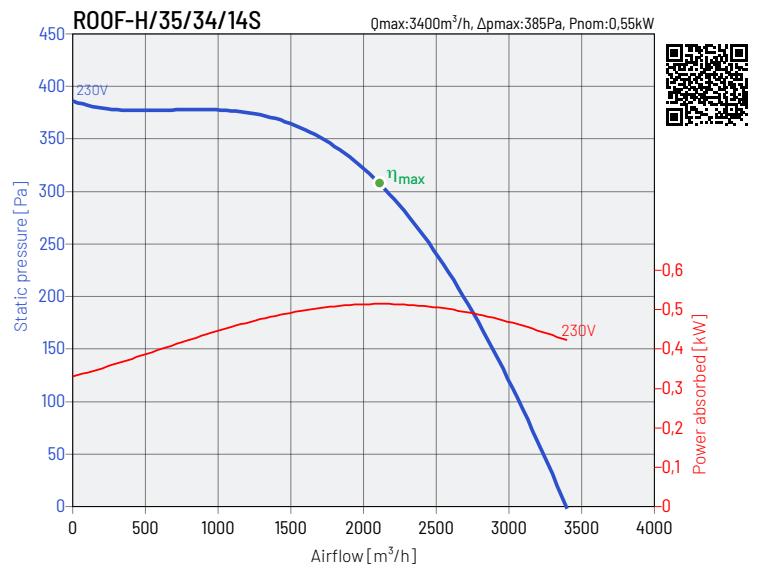
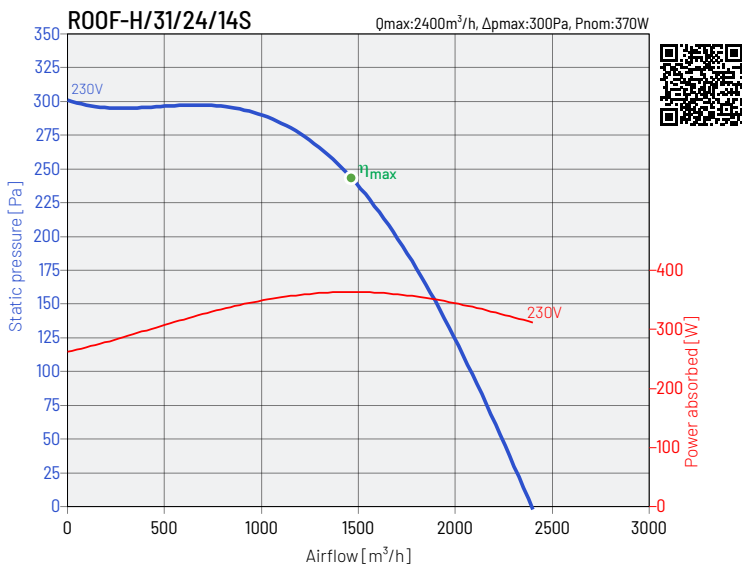
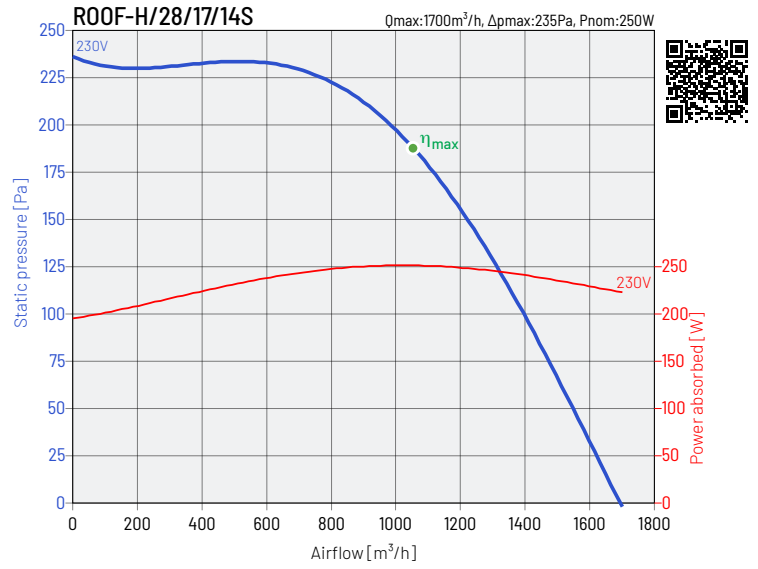
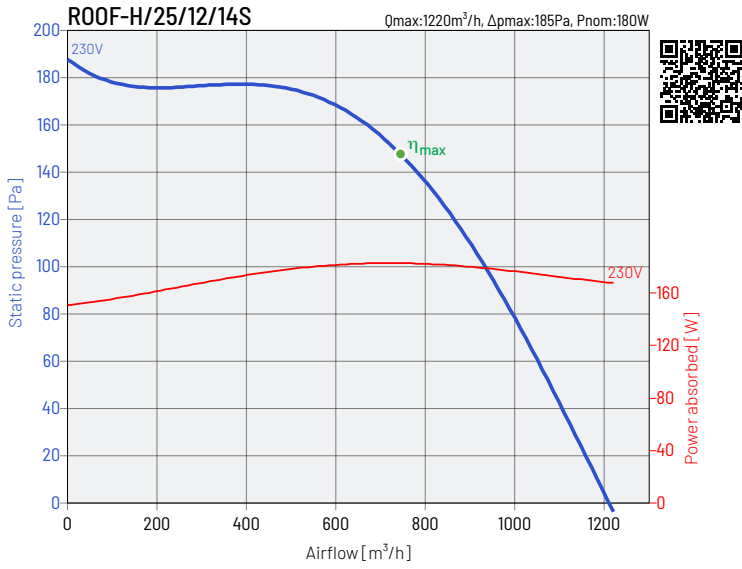



## PERFORMANCE CHARACTERISTICS OF THE FANS

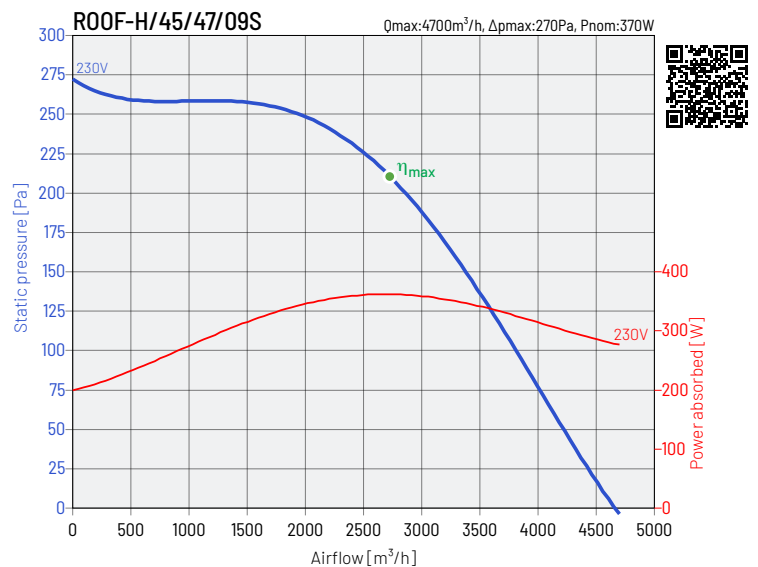
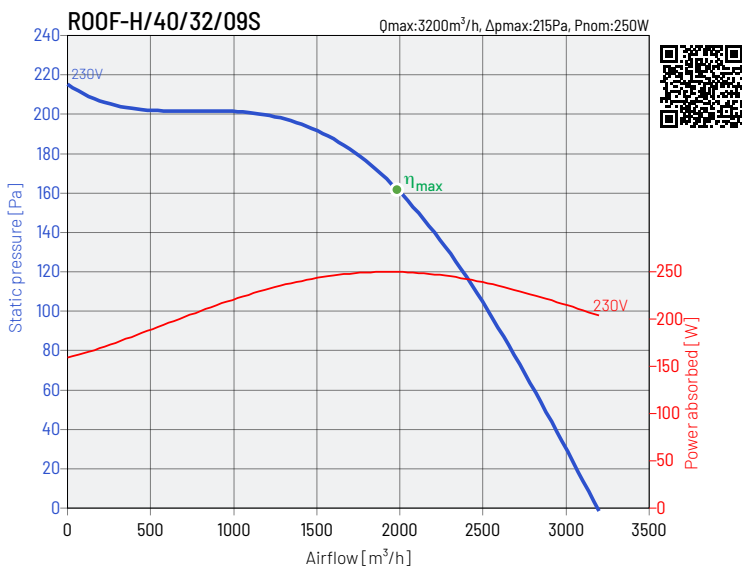
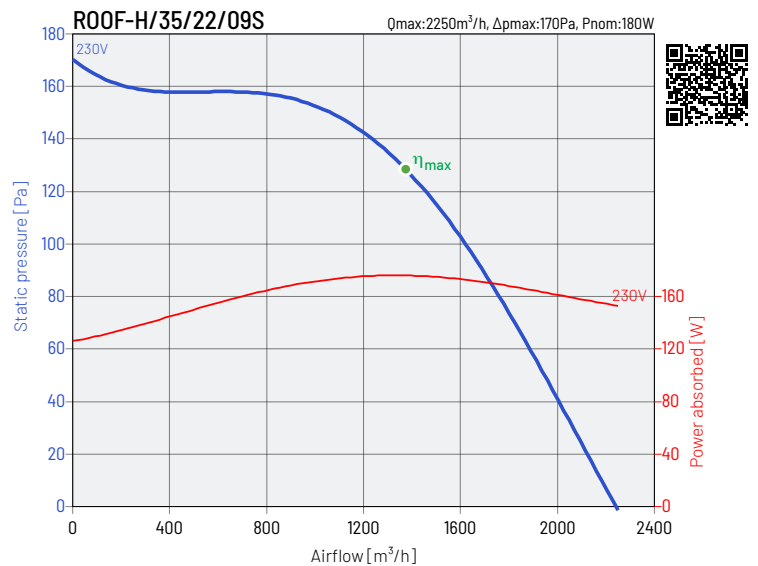
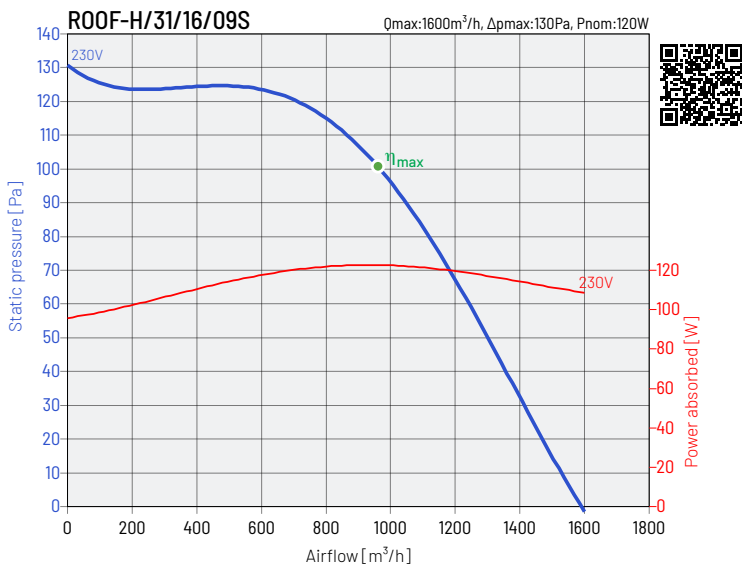
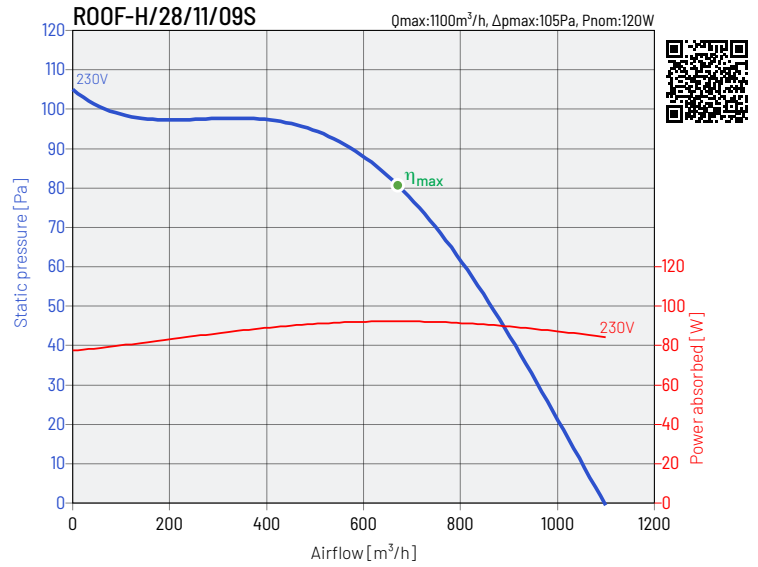
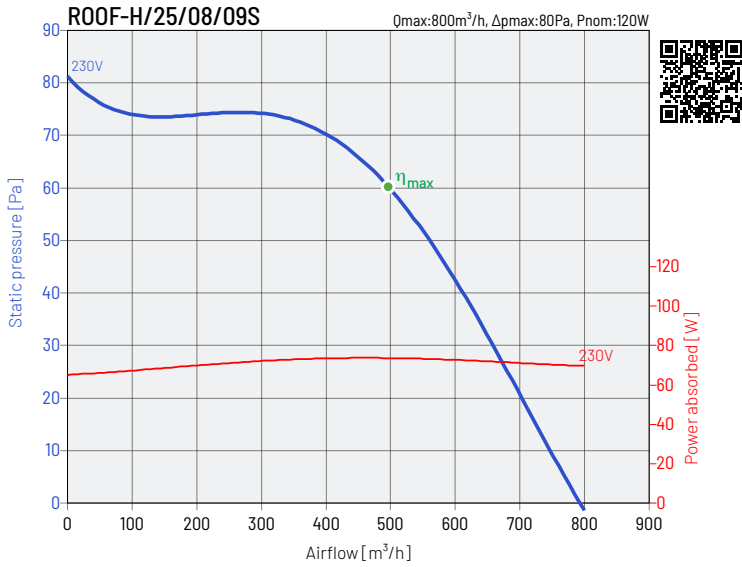



## PERFORMANCE CHARACTERISTICS OF THE FANS

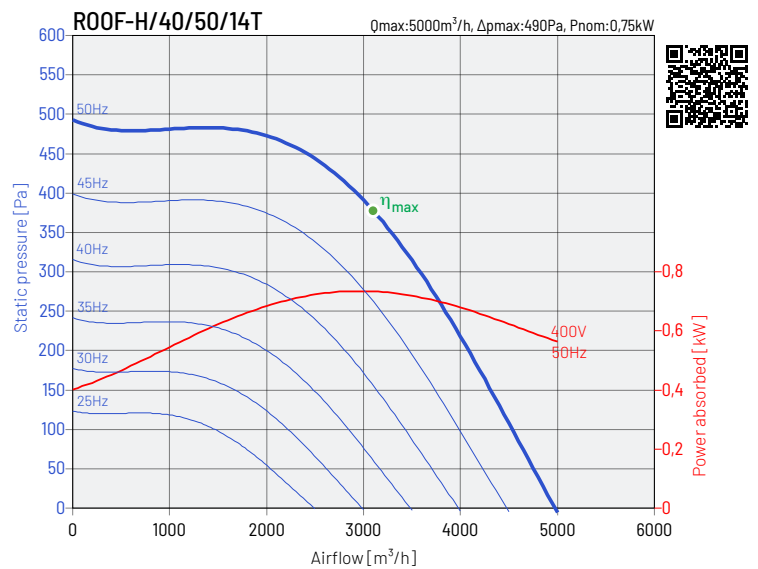
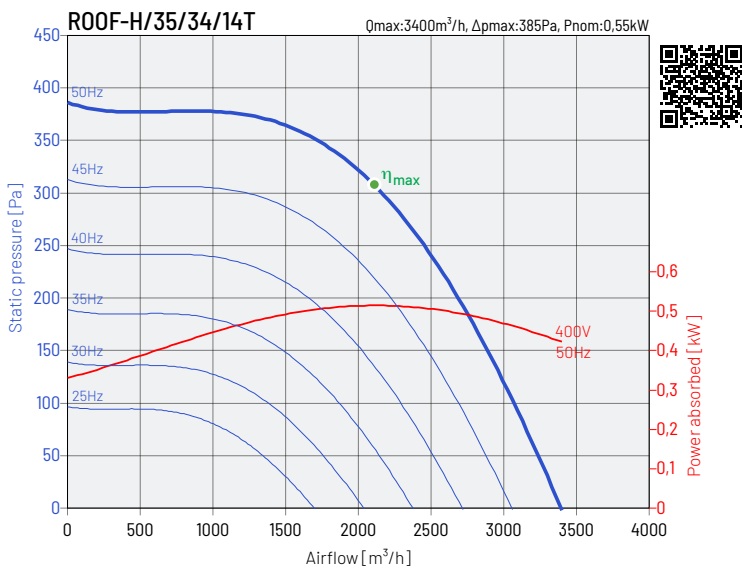
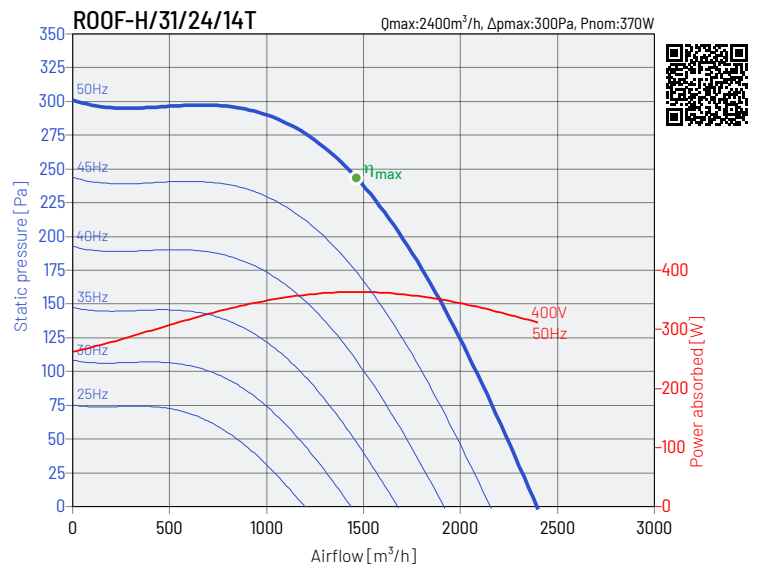
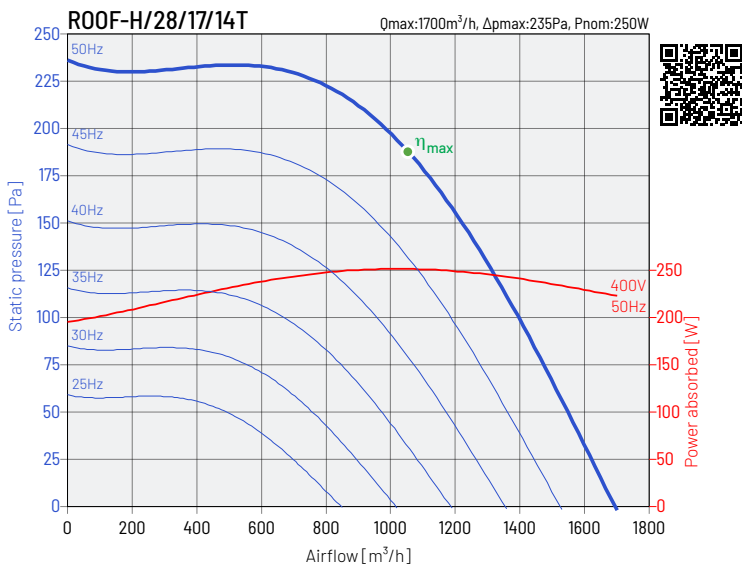
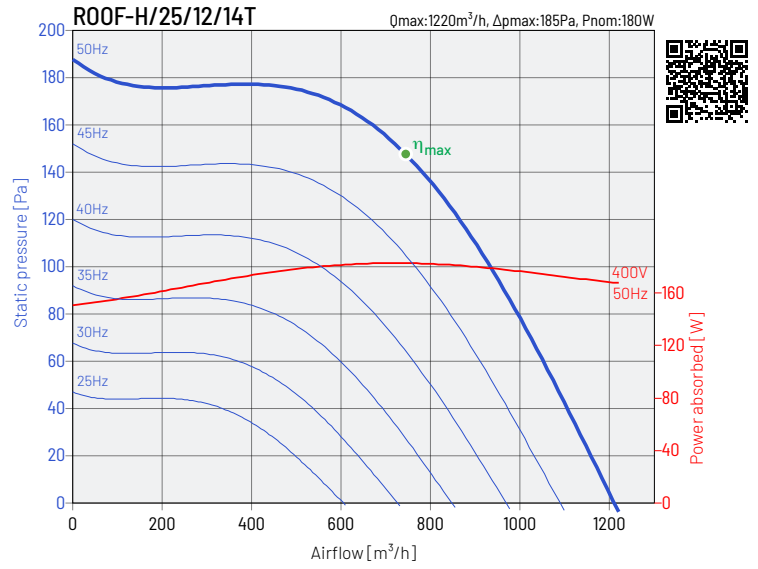
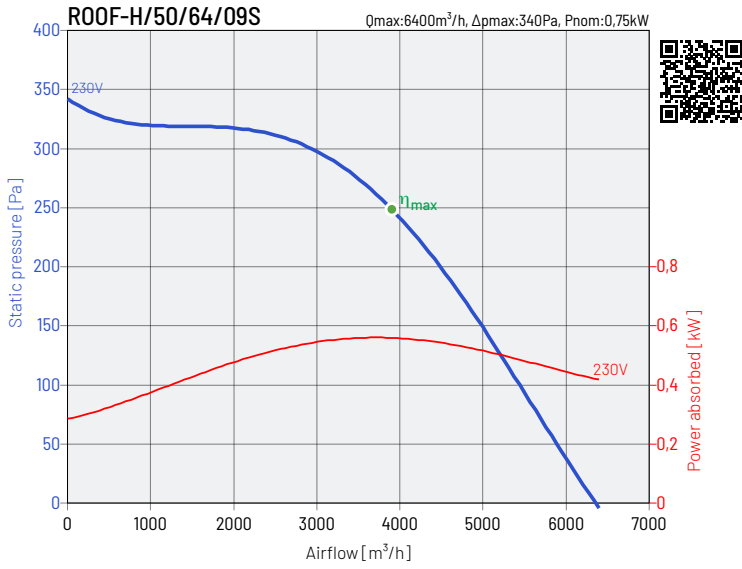



## PERFORMANCE CHARACTERISTICS OF THE FANS

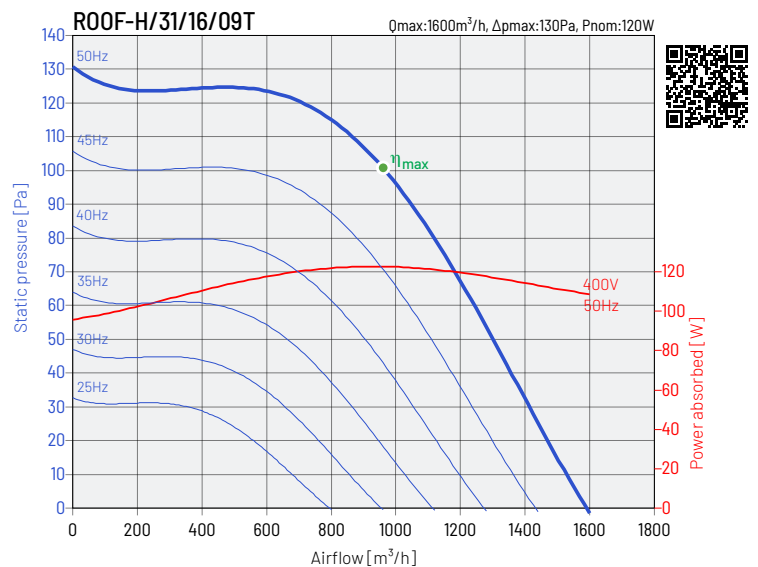
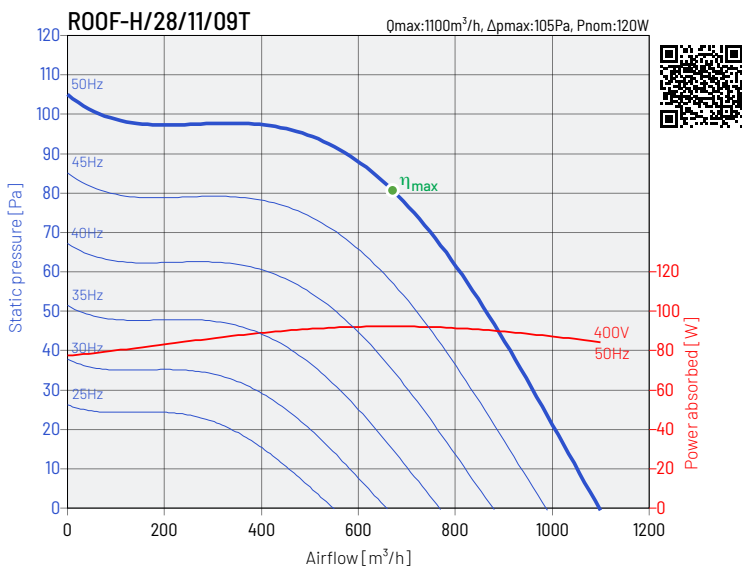
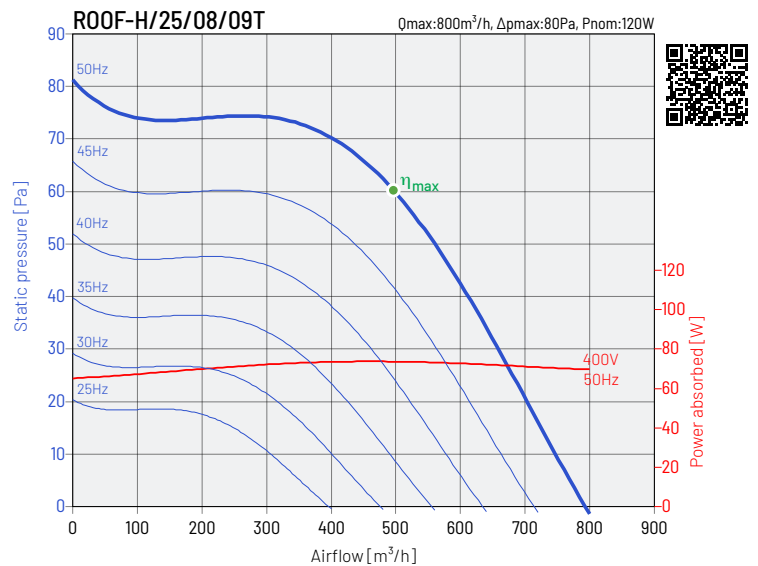
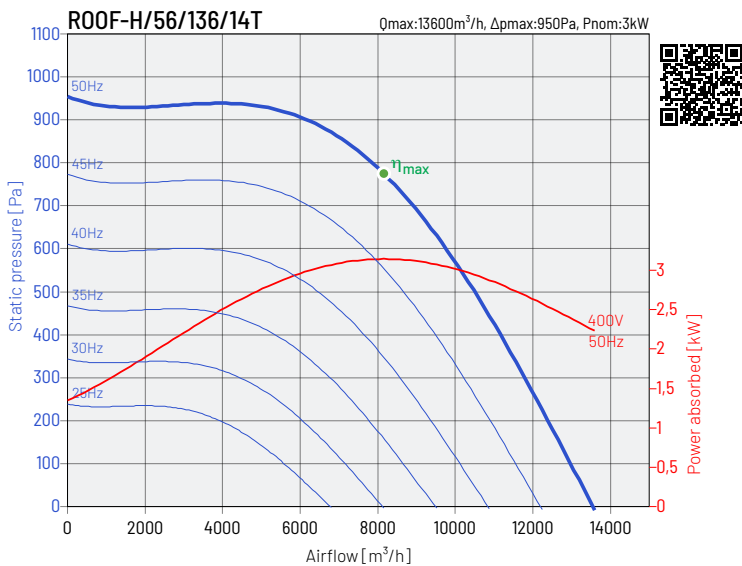
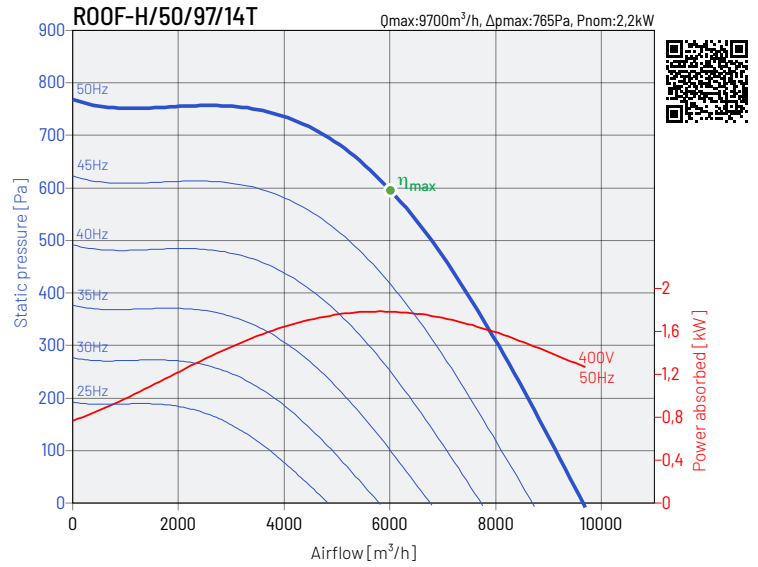
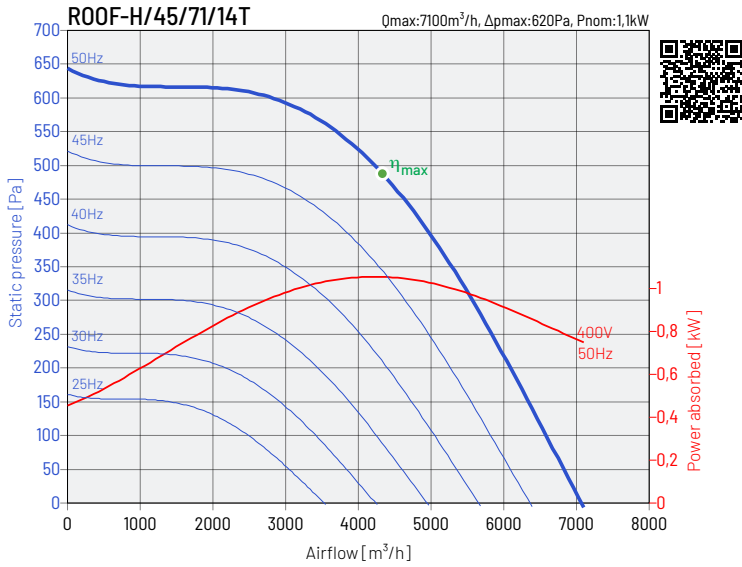



## PERFORMANCE CHARACTERISTICS OF THE FANS

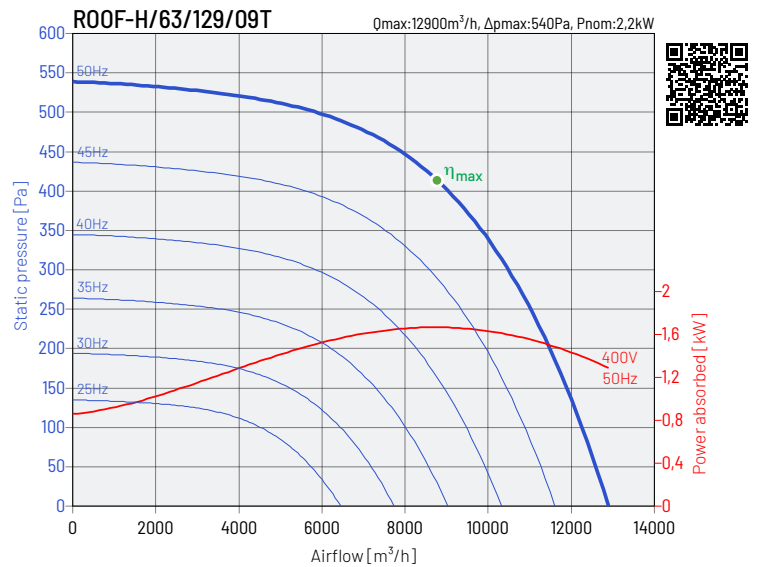
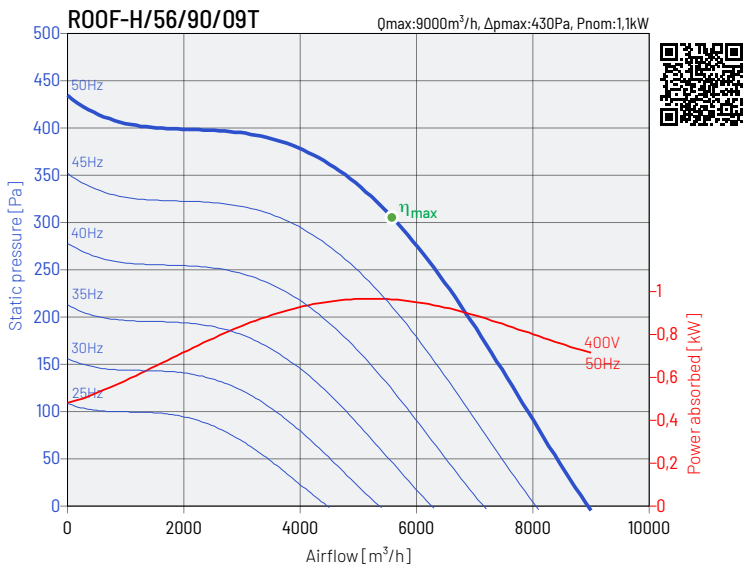
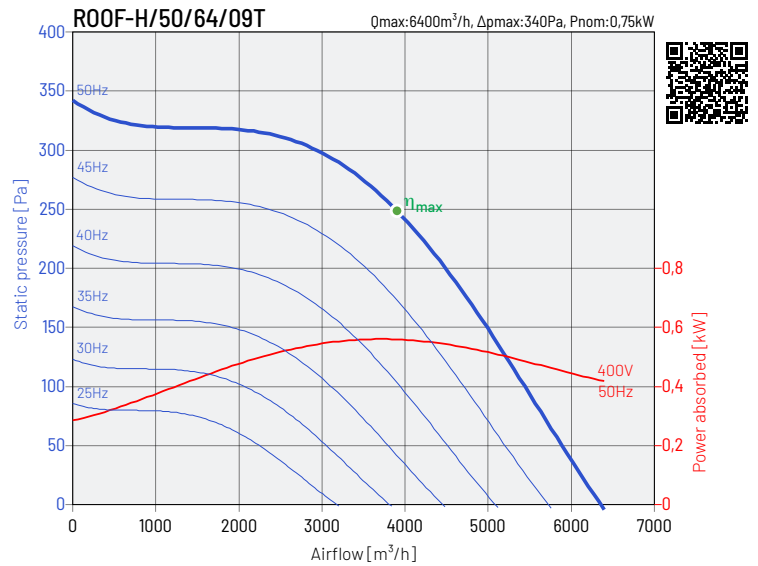
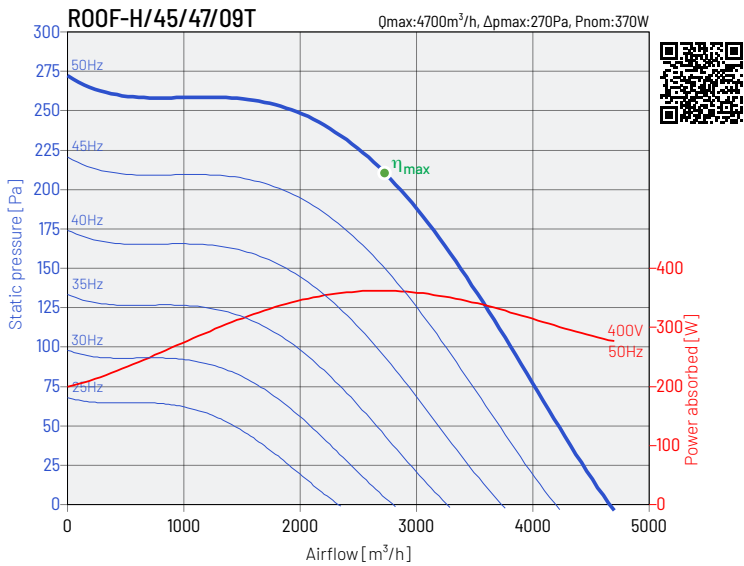
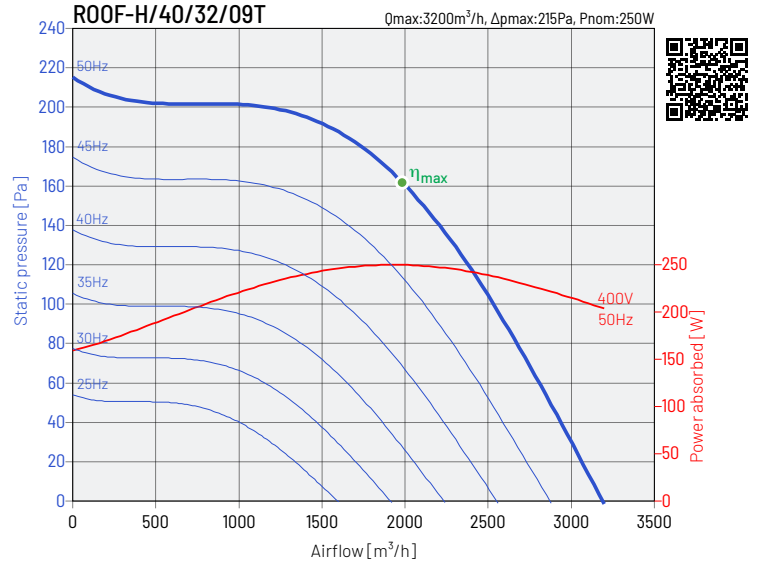
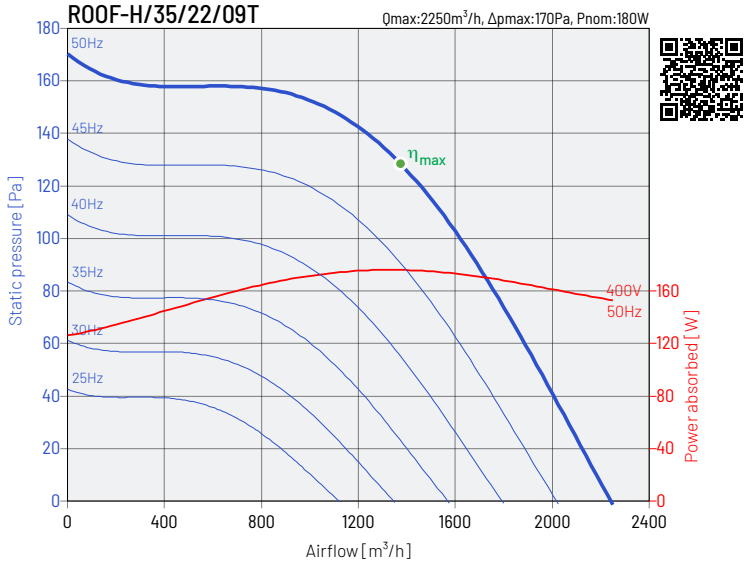



## PERFORMANCE CHARACTERISTICS OF THE FANS

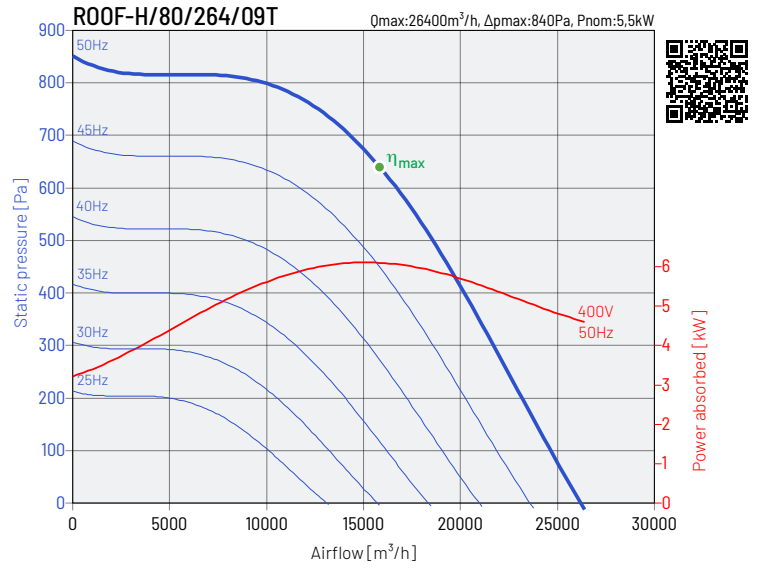
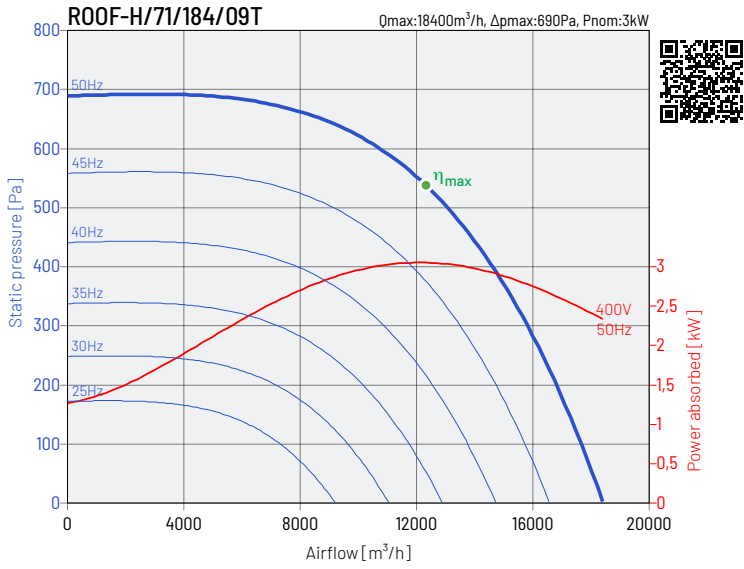



# ROOF-H Roof fan

The power of AIR



## DIMENSIONS

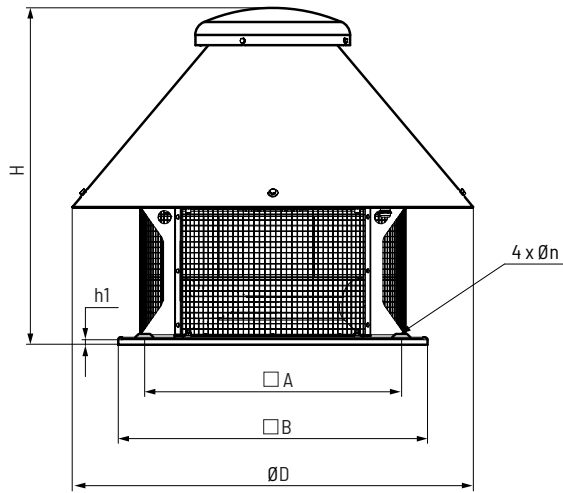

type	A mm	B mm	ØD mm	H mm	h1 mm	Øn mm
ROOF-H/25	330	435	510	456	15	12
ROOF-H/28	330	435	510	456	15	12
ROOF-H/31	330	435	570	471	15	12
ROOF-H/35	450	560	680	606	15	12
ROOF-H/40	450	560	730	623	15	12
ROOF-H/45	535	630	800	666	15	12
ROOF-H/50	590	710	920	773	17	12
ROOF-H/56	590	710	1000	762	17	12
ROOF-H/63	750	900	1115	935	40	14
ROOF-H/71	750	900	1250	1060	40	14
ROOF-H/80	840	1100	1410	1185	40	14



## MOUNTING ACCESSORIES

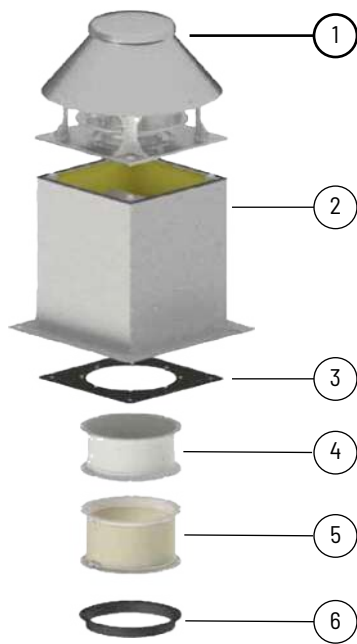

type	flat roof up RSS	flat roof up RS	flat roof up RS-I	flat roof up RSA	flat roof up RSA-I
ROOF-H/25	RSS 435	RS 435	RS-I 435	RSA 435	RSA-I 435
ROOF-H/28	RSS 435	RS 435	RS-I 435	RSA 435	RSA-I 435
ROOF-H/31	RSS 435	RS 435	RS-I 435	RSA 435	RSA-I 435
ROOF-H/35	RSS 560	RS 560	RS-I 560	RSA 560	RSA-I 560
ROOF-H/40	RSS 560	RS 560	RS-I 560	RSA 560	RSA-I 560
ROOF-H/45	RSS 630	RS 630	RS-I 630	RSA 630	RSA-I 630
ROOF-H/50	RSS 710	RS 710	RS-I 710	RSA 710	RSA-I 710
ROOF-H/56	RSS 710	RS 710	RS-I 710	RSA 710	RSA-I 710
ROOF-H/63	RSS 905	RS 905	RS-I 905	RSA 905	RSA-I 905
ROOF-H/71	RSS 905	RS 905	RS-I 905	RSA 905	RSA-I 905
ROOF-H/80	RSS 1100	RS 1100	RS-I 1100	RSA 1100	RSA-I 1100



type	mounting plate P	backflow preventer KZD SE	connector anti-vibration ZDPO	stub-pipe K
ROOF-H/25	P 435	KZD SE 435	ZDPO 435	K 435
ROOF-H/28	P 435	KZD SE 435	ZDPO 435	K 435
ROOF-H/31	P 435	KZD SE 435	ZDPO 435	K 435
ROOF-H/35	P 560	KZD SE 560	ZDPO 560	K 560
ROOF-H/40	P 560	KZD SE 560	ZDPO 560	K 560
ROOF-H/45	P 630	KZD SE 630	ZDPO 630	K 630
ROOF-H/50	P 710	KZD SE 710	ZDPO 710	K 710
ROOF-H/56	P 710	KZD SE 710	ZDPO 710	K 710
ROOF-H/63	P 905	KZD SE 905	ZDPO 905	K 905
ROOF-H/71	P 905	KZD SE 905	ZDPO 905	K 905
ROOF-H/80	P 1100	KZD SE 1100	ZDPO 1100	K 1100

### Article numbers

43526520	RSS 435	43526020	RS 435	43526120	RSA 435	43526310	P 435	43527410	ZDPO 435	43526410	K 435
43526530	RSS 560	43526030	RS 560	43526130	RSA 560	43526320	P 560	43527420	ZDPO 560	43526420	K 560
43526540	RSS 630	43526040	RS 630	43526140	RSA 630	43526330	P 630	43527430	ZDPO 630	43526430	K 630
43526550	RSS 710	43526050	RS 710	43526150	RSA 710	43526340	P 710	43527440	ZDPO 710	43526440	K 710
43526560	RSS 905	43526060	RS 905	43526160	RSA 905	43526350	P 905	43527450	ZDPO 905	43526450	K 905
43526570	RSS 1100	43526070	RS 1100	43526170	RSA 1100	43526360	P 1100	43527460	ZDPO 1100	43526460	K 1100
43526580	RSS 1250	43526080	RS 1250	43526180	RSA 1250	43526370	P 1250	43527470	ZDPO 1250	43526470	K 1250
		43526721	RS-I 435	43526821	RSA-I 435	43527312	KZD SE 435				
		43526731	RS-I 560	43526831	RSA-I 560	43527322	KZD SE 560				
		43526741	RS-I 630	43526841	RSA-I 630	43527332	KZD SE 630				
		43526751	RS-I 710	43526851	RSA-I 710	43527342	KZD SE 710				
		43526761	RS-I 905	43526861	RSA-I 905	43527352	KZD SE 905				
		43526771	RS-I 1100	43526871	RSA-I 1100	43527362	KZD SE 1100				
		43526781	RS-I 1250	43526881	RSA-I 1250	43527372	KZD SE 1250				



## ELECTRICAL ACCESSORIES



type	wall thermostat	duct thermostat	sensor temperature	air quality sensor	humidistat	thyristor controller
	TS*	TK-21	for TK-21	SQA	HIG-2	REB
ROOF-H/25/12/14S	TS	TK-21	Sensor TK-21	SQA	HIG-2	REB-5
ROOF-H/28/17/14S	TS	TK-21	Sensor TK-21	SQA + DILM7-10	HIG-2 + DILM7-10	REB-5
ROOF-H/31/24/14S	TS + DILM7-10	TK-21	Sensor TK-21	SQA + DILM7-10	HIG-2 + DILM7-10	REB-5
ROOF-H/35/34/14S	TS + DILM7-10	TK-21 + DILM7-10	Sensor TK-21	SQA + DILM7-10	HIG-2 + DILM7-10	REB-10
ROOF-H/40/50/14S	TS + DILM7-10	TK-21 + DILM7-10	Sensor TK-21	SQA + DILM7-10	HIG-2 + DILM7-10	REB-10
ROOF-H/45/71/14S	TS + DILM7-10	TK-21 + DILM7-10	Sensor TK-21	SQA + DILM7-10	HIG-2 + DILM7-10	REB-10
ROOF-H/25/08/09S	TS	TK-21	Sensor TK-21	SQA	HIG-2	REB-5
ROOF-H/28/11/09S	TS	TK-21	Sensor TK-21	SQA	HIG-2	REB-5
ROOF-H/31/16/09S	TS	TK-21	Sensor TK-21	SQA	HIG-2	REB-5
ROOF-H/35/22/09S	TS	TK-21	Sensor TK-21	SQA	HIG-2	REB-5
ROOF-H/40/32/09S	TS	TK-21	Sensor TK-21	SQA + DILM7-10	HIG-2 + DILM7-10	REB-5
ROOF-H/45/47/09S	TS + DILM7-10	TK-21	Sensor TK-21	SQA + DILM7-10	HIG-2 + DILM7-10	REB-10
ROOF-H/50/64/09S	TS + DILM7-10	TK-21 + DILM7-10	Sensor TK-21	SQA + DILM7-10	HIG-2 + DILM7-10	REB-10
ROOF-H/25/12/14T	TS + DILM7-10	TK-21 + DILM7-10	Sensor TK-21	SQA + DILM7-10	HIG-2 + DILM7-10	-
ROOF-H/28/16/14T	TS + DILM7-10	TK-21 + DILM7-10	Sensor TK-21	SQA + DILM7-10	HIG-2 + DILM7-10	-
ROOF-H/31/23/14T	TS + DILM7-10	TK-21 + DILM7-10	Sensor TK-21	SQA + DILM7-10	HIG-2 + DILM7-10	-
ROOF-H/35/33/14T	TS + DILM7-10	TK-21 + DILM7-10	Sensor TK-21	SQA + DILM7-10	HIG-2 + DILM7-10	-
ROOF-H/40/48/14T	TS + DILM7-10	TK-21 + DILM7-10	Sensor TK-21	SQA + DILM7-10	HIG-2 + DILM7-10	-
ROOF-H/45/68/14T	TS + DILM7-10	TK-21 + DILM7-10	Sensor TK-21	SQA + DILM7-10	HIG-2 + DILM7-10	-
ROOF-H/50/93/14T	TS + DILM7-10	TK-21 + DILM7-10	Sensor TK-21	SQA + DILM7-10	HIG-2 + DILM7-10	-
ROOF-H/56/130/14T	TS + DILM7-10	TK-21 + DILM7-10	Sensor TK-21	SQA + DILM7-10	HIG-2 + DILM7-10	-
ROOF-H/25/08/09T	TS + DILM7-10	TK-21 + DILM7-10	Sensor TK-21	SQA + DILM7-10	HIG-2 + DILM7-10	-
ROOF-H/28/11/09T	TS + DILM7-10	TK-21 + DILM7-10	Sensor TK-21	SQA + DILM7-10	HIG-2 + DILM7-10	-
ROOF-H/31/16/09T	TS + DILM7-10	TK-21 + DILM7-10	Sensor TK-21	SQA + DILM7-10	HIG-2 + DILM7-10	-
ROOF-H/35/21/09T	TS + DILM7-10	TK-21 + DILM7-10	Sensor TK-21	SQA + DILM7-10	HIG-2 + DILM7-10	-
ROOF-H/40/31/09T	TS + DILM7-10	TK-21 + DILM7-10	Sensor TK-21	SQA + DILM7-10	HIG-2 + DILM7-10	-
ROOF-H/45/46/09T	TS + DILM7-10	TK-21 + DILM7-10	Sensor TK-21	SQA + DILM7-10	HIG-2 + DILM7-10	-
ROOF-H/50/62/09T	TS + DILM7-10	TK-21 + DILM7-10	Sensor TK-21	SQA + DILM7-10	HIG-2 + DILM7-10	-
ROOF-H/56/88/09T	TS + DILM7-10	TK-21 + DILM7-10	Sensor TK-21	SQA + DILM7-10	HIG-2 + DILM7-10	-
ROOF-H/63/125/09T	TS + DILM7-10	TK-21 + DILM7-10	Sensor TK-21	SQA + DILM7-10	HIG-2 + DILM7-10	-
ROOF-H/71/178/09T	TS + DILM7-10	TK-21 + DILM7-10	Sensor TK-21	SQA + DILM7-10	HIG-2 + DILM7-10	-
ROOF-H/80/256/09T	TS + DILM15-10	TK-21 + DILM15-10	Sensor TK-21	SQA + DILM15-10	HIG-2 + DILM15-10	-

\* single phase motor use all tracks in the contactor



## ELECTRICAL ACCESSORIES



type	11-speed thyristor controller	transformer regulator		transformer regulator 2-adjustable	inverter
	IRF	RMB	RVS	SC2A	L
ROOF-H/25/12/14S	IRF-900	RMB 3,5	RVS 3	SC2A1-25L25	-
ROOF-H/28/17/14S	IRF-900	RMB 3,5	RVS 3	SC2A1-25L25	-
ROOF-H/31/24/14S	IRF-900	RMB 3,5	RVS 5	SC2A1-35L25	-
ROOF-H/35/34/14S	IRF-900	RMB 8	RVS 5	SC2A1-50L25	-
ROOF-H/40/50/14S	IRF-900	RMB 8	RVS 5	SC2A1-50L25	-
ROOF-H/45/71/14S	-	RMB 10	RVS 10	SC2A1-110L25	-
ROOF-H/25/08/09S	IRF-900	RMB 3,5	RVS 3	SC2A1-25L25	-
ROOF-H/28/11/09S	IRF-900	RMB 3,5	RVS 3	SC2A1-25L25	-
ROOF-H/31/16/09S	IRF-900	RMB 3,5	RVS 3	SC2A1-25L25	-
ROOF-H/35/22/09S	IRF-900	RMB 3,5	RVS 3	SC2A1-25L25	-
ROOF-H/40/32/09S	IRF-900	RMB 3,5	RVS 3	SC2A1-25L25	-
ROOF-H/45/47/09S	IRF-900	RMB 3,5	RVS 5	SC2A1-50L25	-
ROOF-H/50/64/09S	IRF-900	RMB 8	RVS 7	SC2A1-75L25	-
ROOF-H/25/12/14T	-	-	-	SC2A4-15L55	L 0.4kW
ROOF-H/28/16/14T	-	-	-	SC2A4-15L55	L 0.4kW
ROOF-H/31/23/14T	-	-	-	SC2A4-15L55	L 0.4kW
ROOF-H/35/33/14T	-	-	-	SC2A4-25L55	L 0.75kW
ROOF-H/40/48/14T	-	-	-	SC2A4-25L55	L 0.75kW
ROOF-H/45/68/14T	-	-	-	SC2A4-40L55	L 1.5kW
ROOF-H/50/93/14T	-	-	-	SC2A4-60L55	L 2.2kW
ROOF-H/56/130/14T	-	-	-	SC2A4-80L55	L 4.0kW
ROOF-H/25/08/09T	-	-	-	SC2A4-15L55	L 0.4kW
ROOF-H/28/11/09T	-	-	-	SC2A4-15L55	L 0.4kW
ROOF-H/31/16/09T	-	-	-	SC2A4-15L55	L 0.4kW
ROOF-H/35/21/09T	-	-	-	SC2A4-15L55	L 0.4kW
ROOF-H/40/31/09T	-	-	-	SC2A4-15L55	L 0.4kW
ROOF-H/45/46/09T	-	-	-	SC2A4-15L55	L 0.4kW
ROOF-H/50/62/09T	-	-	-	SC2A4-25L55	L 0.75kW
ROOF-H/56/88/09T	-	-	-	SC2A4-40L55	L 1.5kW
ROOF-H/63/125/09T	-	-	-	SC2A4-40L55	L 2.2kW
ROOF-H/71/178/09T	-	-	-	SC2A4-80L55	L 4.0kW
ROOF-H/80/256/09T	-	-	-	-	L 5.5kW

### Article numbers

91040997 DILM7-10	40025345 TS	40025051 REB-5	40025234 RVS 3	40025253 SC2A1-25L25	40016302 L 0.4kW
91040666-42 DILM15-10	40025320 TK-21	40025055 REB-10	40025235 RVS 5	40025255 SC2A1-35L25	40016312 L 0.75kW
91040905 DILM25-10	40025140 SQA	40015154 IRF-900	40025236 RVS 7	40025257 SC2A1-50L25	40016322 L 1.5kW
91040666 DILM40-10	40025150 HIG-2	40025070 RMB 3,5	40025237 RVS 10	40025259 SC2A1-75L25	40016332 L 2.2kW
		40025080 RMB 8		40025251 SC2A1-110L25	40016352 L 4.0kW
		40025090 RMB 10		40025270 SC2A4-15L55	40016362 L 5.5kW
				40025272 SC2A4-25L55	40016383 L 11kW
				40025274 SC2A4-40L55	40016412 L 18.5kW
				40025276 SC2A4-60L55	
				40025278 SC2A4-80L55	