

# MN

**ASPIRATORE VENTILATORE CENTRIFUGO**  
**CENTRIFUGAL FAN**



**GIRANTE A PALE CURVE AVANTI**  
**FORWARD CURVED BLADES IMPELLER**



**BASSA PRESSIONE**  
**LOW PRESSURE**

**Portata/Flow rate:**  
**50 ÷ 2500 m<sup>3</sup>/h**

**Pressione/Pressure:**  
**23 ÷ 150 mm H<sub>2</sub>O**





# MN

## ASPIRATORE VENTILATORE CENTRIFUGO CENTRIFUGAL FAN



I ventilatori della serie MN sono indicati per il raffreddamento di estrusori, lampade, motori in corrente continua, per l'aspirazione di fumi ed esalazioni e per le applicazioni in cui sia necessario muovere fluidi puliti o leggermente polverosi mediante canalizzazioni.

L'esecuzione standard prevede l'utilizzo di coclee in lamiera di acciaio stampata e saldata mediante puntatura elettrica, giranti a pale avanti in lamiera zincata e l'installazione di motori elettrici a 2 o 4 poli.

I fluidi trasportati possono raggiungere una temperatura massima di 80°C in esecuzione standard; nel caso di esecuzioni speciali, sono ammessi valori massimi di 250°C.

A richiesta sono disponibili esecuzioni in acciaio inossidabile, anche in conformità alla direttiva ATEX (94/9/CE).

*MN series blower are suitable for extruders, lamps, c.c motors cooling, for smokes and exhalations suction, for applications in which moving clean or clearly dusty fluids is required. Standard execution blowers are provided with pressed and spot welded steel sheets casings, forwarded blades galvanized impellers and 2 or 4 poles electrical motors. Transported fluids can reach maximum temperature of 80°C for standard execution; for special executions maximum values of 250°C are allowed. On demand, special stainless steel execution are available, also according to ATEX directive (94/9/CE).*



**Esecuzione speciale per gas caldi**  
Special high temperature execution



**Acciaio inossidabile**  
Stainless steel



**Orientamento RD 270**  
Position RD 270

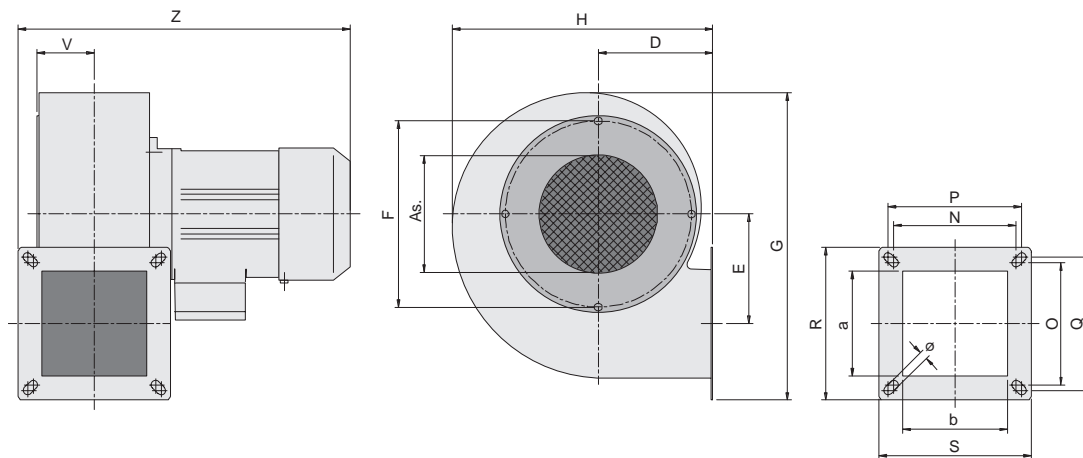

**Direzioni di rotazione (vista lato motore) - Rotation senses (seen from motor side)**

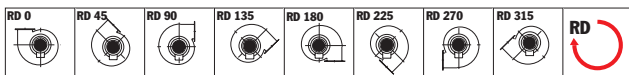

Rotazione oraria - Clockwise rotation sense

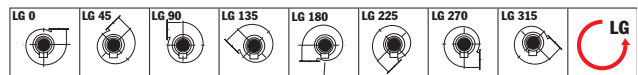

Rotazione anti-oraria - Anti-Clockwise rotation sense

**Peso ventilatore in Kg (completo di motore) - Weight of ventilator (complete with motor)**

**Nota: quota Z indicativa - Note: 'Z' quote indicative**

TIPO - TYPE		kW inst.	PESO WEIGHT	VENTILATORE FAN																
VENTILATORE FAN	MOTORE MOTOR			kgf	As.	F	D	E	G	H	a	b	N	O	P	Q	φ	R	S	V
<b>MN 202</b>	-	0,09	2,5	85	120	85	62	190	168	60	70	85	75	93	90	7	105	110	39	223
<b>MN 252</b>	-	0,09	3	112	150	100	94	270	223	82	85	110	110	128	128	7	140	140	44	232
<b>MN 302</b>	<b>63 M2</b>	0,18	5,5	112	150	100	94	270	223	85	85	110	110	128	128	7	140	140	47	270
<b>MN 402</b>	<b>63 M2</b>	0,25	6	112	150	100	94	270	223	85	110	128	103	138	115	9	130	155	60	295
<b>MN 502</b>	<b>71 M2</b>	0,37	9,5	122	195	120	115	322	273	110	110	128	128	140	140	9	160	160	60	318
<b>MN 504</b>	<b>63 M4</b>	0,18	6	122	195	120	115	322	273	110	110	128	128	140	140	9	160	160	60	295
<b>MN 552</b>	<b>71 M2</b>	0,55	10	158	195	120	115	322	273	110	110	128	128	140	140	9	160	160	60	318
<b>MN 554</b>	<b>63 M4</b>	0,18	7	158	195	120	115	322	273	110	110	128	128	140	140	9	160	160	60	295
<b>MN 602</b>	<b>80 M2</b>	1,1	20	180	222	156	145	405	338	140	140	160	160	170	170	9	190	190	77	385
<b>MN 604</b>	<b>71 M4</b>	0,25	12	180	222	156	145	405	338	140	140	160	160	170	170	9	190	190	77	338



# DIRETTAMENTE ACCOPPIATI CON MOTORE A 2/4 POLI

## DIRECT CONNECTION FOR 2/4 POLES MOTORS

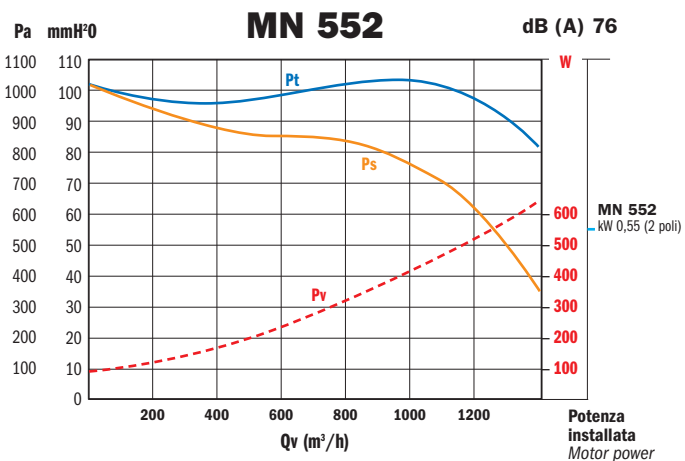
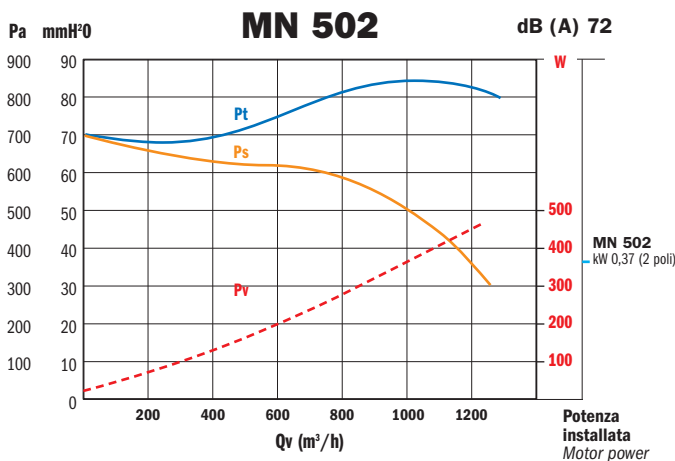
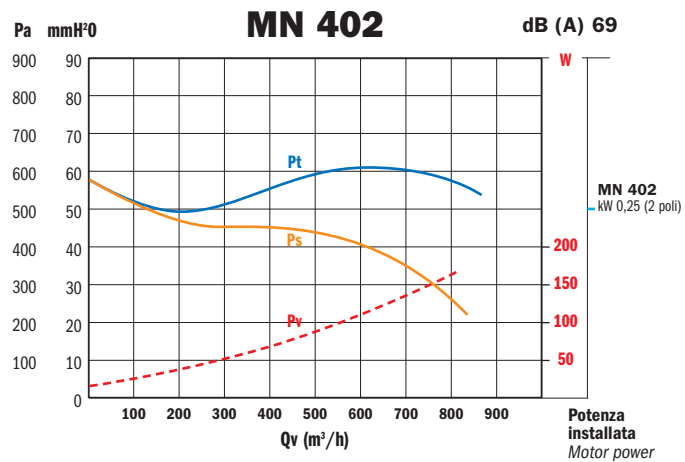
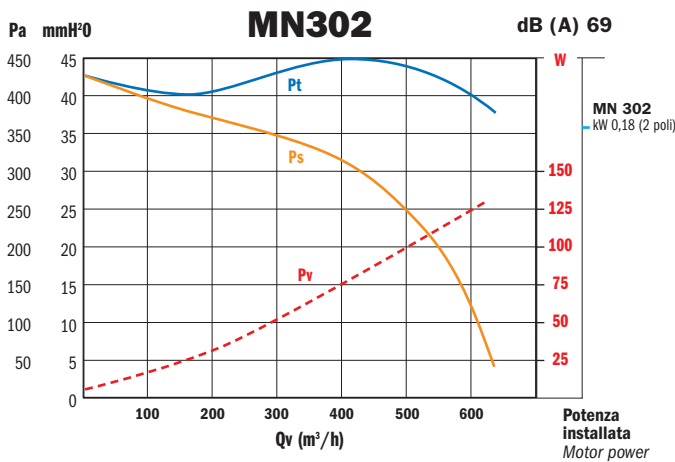
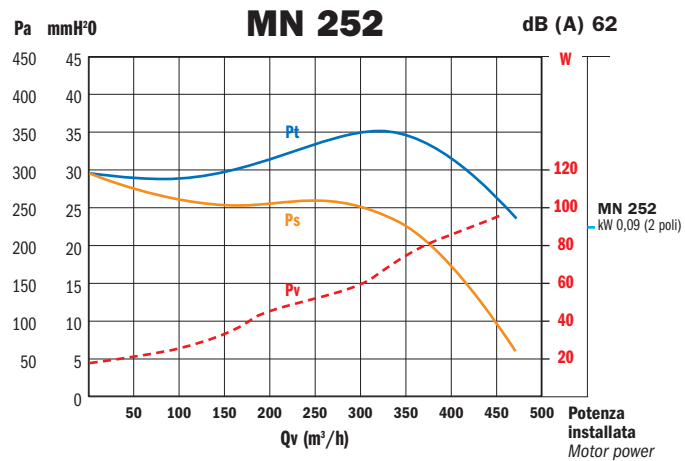
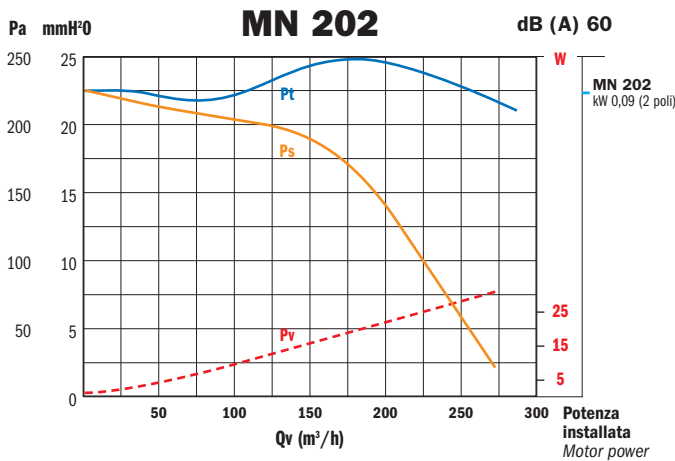

Valori riferiti a: / Datas referring to: T=15°C; P=1 atm

— Pt= Pressione totale - Total pressure    — Ps= Pressione statica - Statical pressure    - - - Pv= Potenza assorbita - Absorbed power

# DIRETTAMENTE ACCOPPIATI CON MOTORE A 2/4 POLI

## DIRECT CONNECTION FOR 2/4 POLES MOTORS

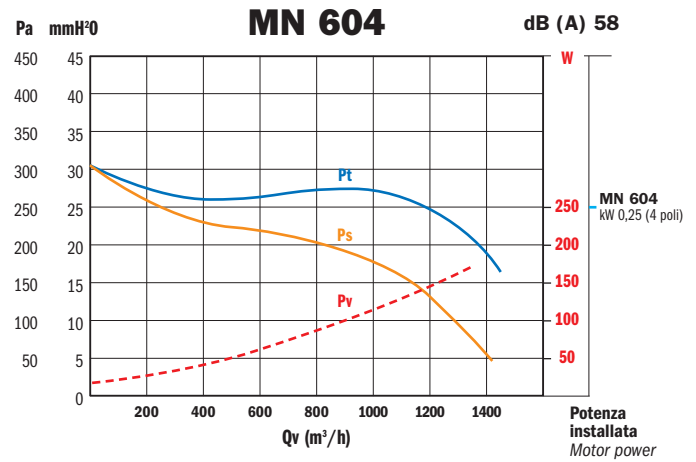
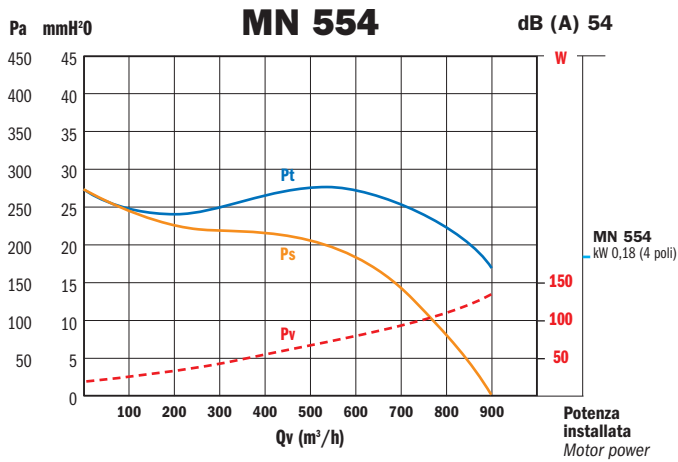
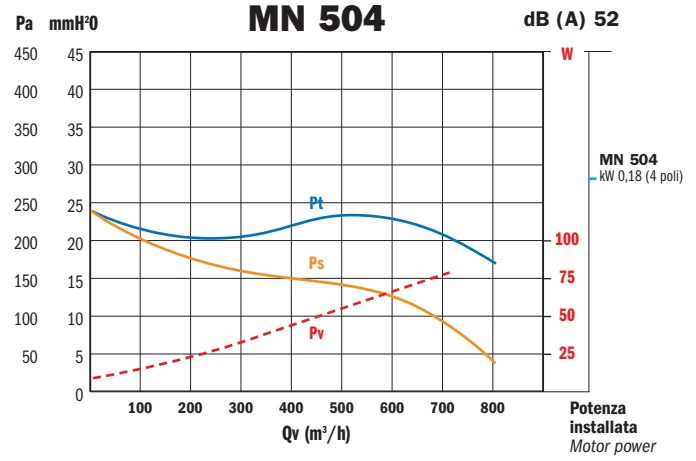
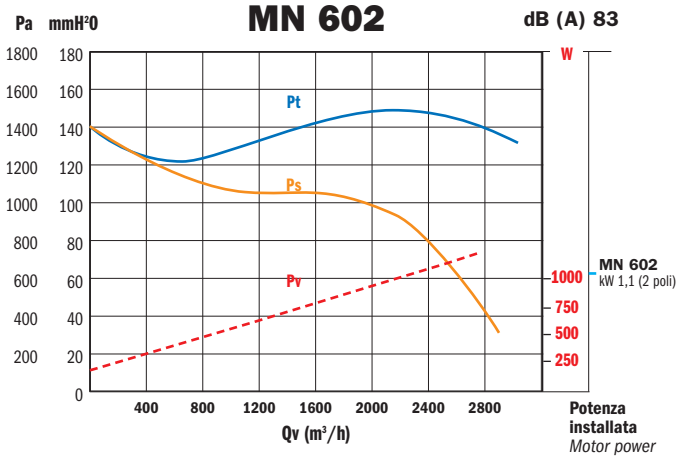

Valori riferiti a: / Datas referring to: T=15°C; P=1 atm

— Pt= Pressione totale - Total pressure    — Ps= Pressione statica - Statical pressure    - - - Pv= Potenza assorbita - Absorbed power

maflo®

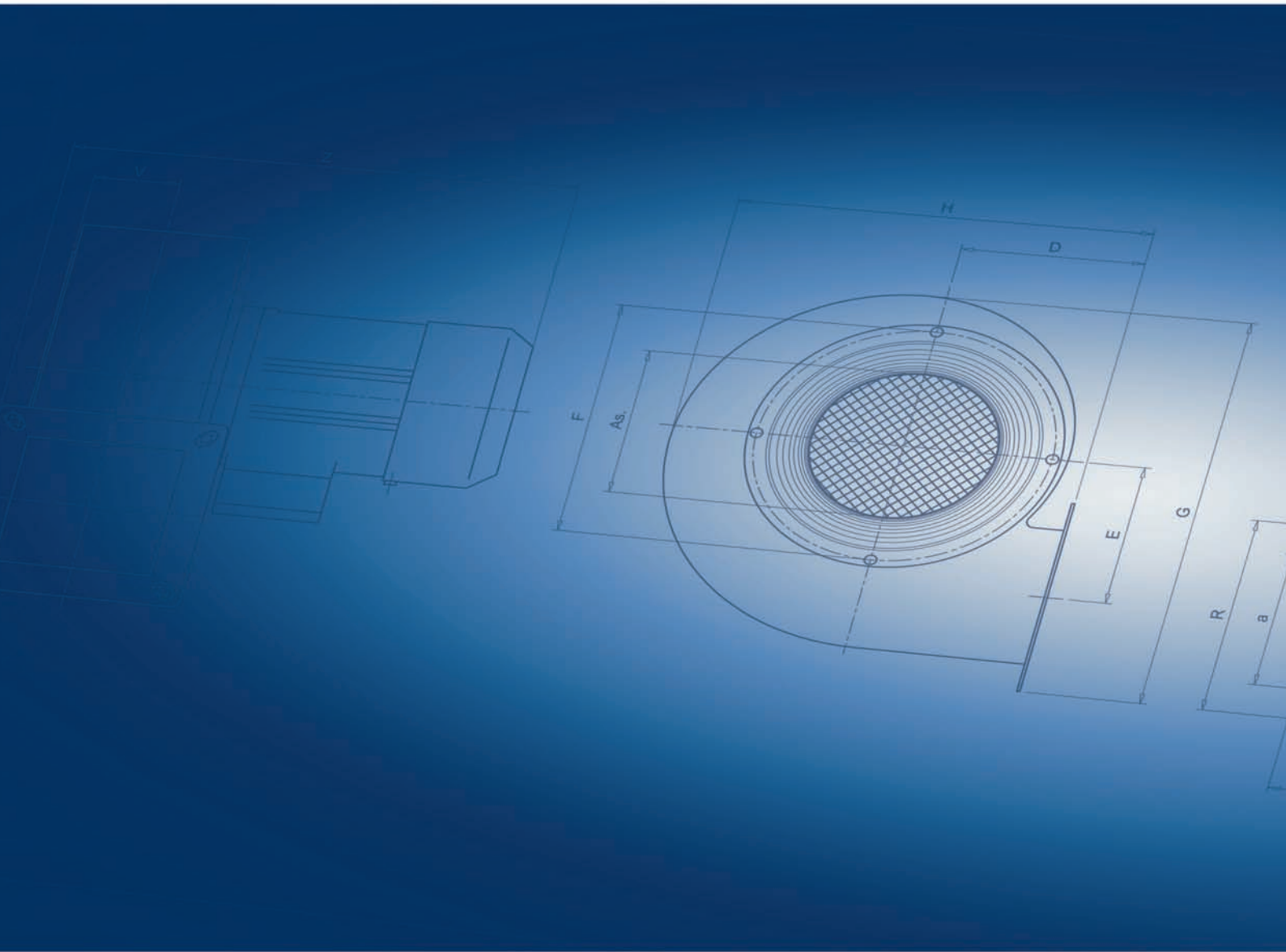

Via Pirandello, 10 - 20030 Barlassina (MI) - Tel. +39 0362 556050 r.a. Fax +39 0362 557261 · e-mail: [info@moro.it](mailto:info@moro.it)  
[www.moro.it](http://www.moro.it)